

diskashur DT™

User's Manual



Table of Contents

About the diskAshur Desktop Drive	4
Package contents	4
diskAshur DT button panel	5
diskAshur DT - Getting Started	6
Before you begin	6
Connecting the diskAshur DT	6
How do I use the diskAshur DT the first time?	7
What if I forget the User Password?	7
Using the diskAshur DT	8
Entering the Standby Mode	8
Entering the User Mode	8
Exiting the User Mode	8
Entering the Admin Mode	9
Exiting the Admin Mode	9
Password Management	10
Changing the Admin Password	10
Adding a new User Password	11
Deleting the User Passwords	11
Changing the User Password	11
Setting the Unattended Auto Lock Feature	12
diskAshur DT Brute Force Protection	13
What is Brute Force Attack?	13
How does the diskAshur DT protect against brute force attack?	13
Setting a Self Destruct Password	14
Completely resetting the diskAshur DT	15
Initializing and formatting the diskAshur DT after a complete reset	15

Hibernating, Suspending, or Logging off	17
Troubleshooting	18
Technical Support	20
Warranty and RMA information	20

Copyright © iStorage, Inc 2011. All rights reserved.

Windows is a registered trademark of Microsoft Corporation.
All other trademarks and copyrights referred to are the property of their respective owners.

Distribution of modified versions of this document is prohibited without the explicit permission of the copyright holder.

Distribution of the work or derivative work in any standard (paper) book form for commercial purposes is prohibited unless prior permission is obtained from the copyright holder.

DOCUMENTATION IS PROVIDED AS IS AND ALL EXPRESS OR IMPLIED CONDITIONS, REPRESENTATIONS AND WARRANTIES, INCLUDING ANY IMPLIED WARRANTY OF MERCHANTABILITY, FITNESS FOR A PARTICULAR PURPOSE OR NON-INFRINGEMENT, ARE DISCLAIMED, EXCEPT TO THE EXTENT THAT SUCH DISCLAIMERS ARE HELD TO BE LEGALLY INVALID

About the diskAshur Desktop Drive



Looking for an effortless way to secure your data? Look no further than the diskAshur DT.

With an easy-to-use keypad design and software free setup, the diskAshur DT enables you to access the drive with your own unique pin. Featuring 256 bit hardware encryption and a super-fast USB 3.0 connection, the diskAshur DT provides seamless real-time encryption, keeping your data safe 24/7.



Package contents

- diskAshur DT
- AC Adapter
- USB 3.0 data cable (backwards compatible with USB 2.0)
- Quick Start Guide



diskAshur DT Button Panel

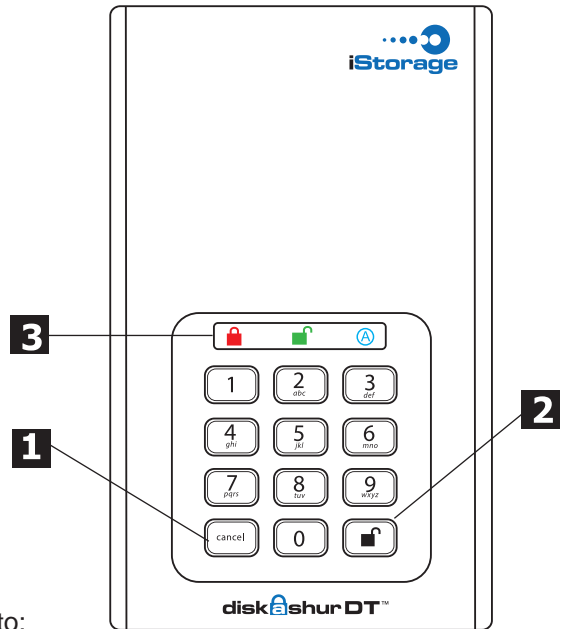
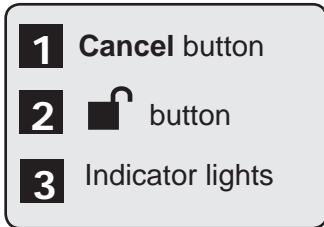



The **“Cancel”** button can be used to:

- Cancel current operation
- Return to the previous step when you knowingly entered a wrong password
- Exit the Admin Mode

The  button can be used to access the diskAshur DT and it can also be used as an OK acknowledgement in the following operations:

- Entering a password
- Confirming a new password

The indicator light displays the following colors to indicate the various modes of operation:

- RED: Standby Mode 
- BLUE: Admin Mode 
- GREEN: User Mode 

The indicator light has other display methods to indicate different status of the diskAshur DT. Details are provided later in this chapter.

diskAshur DT - Getting Started

Before you begin

Be sure to review the following information before you begin to use the diskAshur DT.



Attention: Use only the included cables with your diskAshur DT. You might damage the drive if you use a cable not included with the diskAshur DT.

Connecting the diskAshur DT

1. Ensure that the power switch on the back of the diskAshur DT is in the OFF position.
2. Connect the diskAshur DT to a power outlet using the included AC Adapter.
3. Attach the USB cable to the diskAshur DT drive and to an available USB port on your computer.
4. Turn the power switch on the back of the diskAshur DT to the ON position.
5. The LOCK indicator light should turn RED, indicating that the drive is now ready to use.

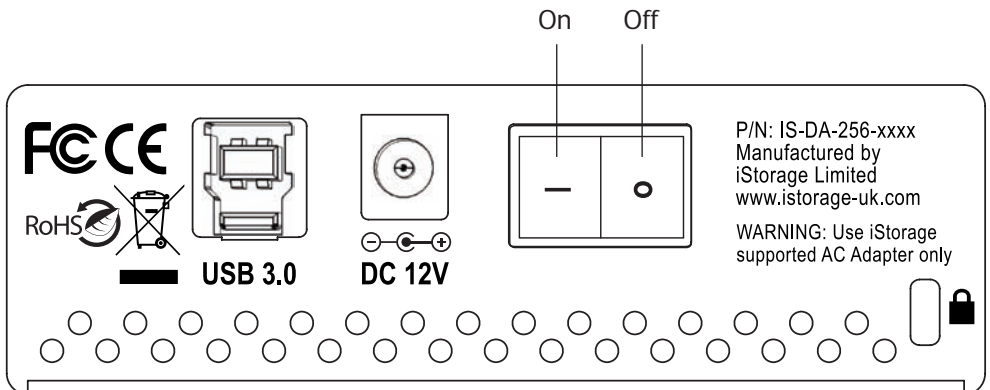

How do I use the diskAshur DT the first time?

You can use it in one of the following ways:

- Enter the Admin Mode with **123456** (default administrator password), and then you are able to change the Admin Password or create a User Password.
- Directly enter the Secure User Mode with **123456** (default Admin Password) to use the diskAshur DT.

What if I forget the User Password?

Use your Admin Password to enter Admin Mode, and then create another User Password in Admin Mode.



NOTE: If you forget or lose your ADMIN password there is no way to access the drive. Even an IStorage employee will be unable to help you access your data. In the event that this happens, the only way to use the drive is to do a complete reset, which will reset the encryption key making all data on the drive unrecoverable and restore the Admin Password to the default **123456**.

See the Chapter “Completely Resetting your diskAshur DT” for instructions.

Using the diskAshur DT

Entering and exiting the Standby Mode, Admin Mode, and User Mode

Entering the Standby Mode

The Standby Mode is the default mode of the diskAshur DT and is the gateway to other operations.

To enter the Standby Mode, attach the diskAshur DT to your computer. The drive automatically goes into Standby Mode and the LOCK indicator light turns RED. In this mode, the diskAshur DT is locked. It cannot be recognized by **My Computer** and it does not provide either the regular functions or the encryption function. However, it enables you to enter and switch between the Admin Mode and the User Mode.



Attention: To switch between the Admin Mode and the User Mode, you are required to switch to the Standby Mode first, and then you can enter the mode of your choice.

Entering the User Mode

To enter the User Mode, do the following:

1. Attach the drive to your computer and to a power outlet using the AC Adapter. Turn the power switch to the ON position. The drive will be in Standby Mode.
2. Enter the User Password or the Admin Password (the default Admin Password is **123456**) and press . The UNLOCK indicator light turns GREEN indicating that the drive is in the User Mode. If the LOCK indicator light flashes RED, you need to re-enter the correct password.

Exiting the User Mode



To exit the User Mode, press the **“Cancel”** button on the diskAshur DT keypad. If there is no activity for 5 seconds the drive will lock and go into Standby mode.

Alternately, you can turn your diskAshur DT OFF at the power switch on the back of the unit. Once you turn the diskAshur DT ON again, the LOCK indicator light will be RED, indicating that you are in the Standby Mode.

Entering the Admin Mode

Note: The diskAshur DT cannot be recognized by the operating system in the Admin Mode.

To enter the Admin Mode, do the following:

1. Attach the USB cable to an available USB port on your computer and turn the diskAshur DT ON. The diskAshur DT goes into the Standby Mode, and the LOCK indicator light turns RED.
2. Press and hold  + 0 for five seconds until the LOCK indicator light flashes RED. This indicates that you can enter the Admin Password.
3. Enter the Admin Password and press . The default Admin Password is **123456**. The drive is in Admin Mode when the ADMIN (A) indicator light has changed to BLUE.



Note: If the LOCK indicator light flashes RED for a few seconds, indicating the diskAshur DT has returned to the Standby Mode, go back to Step 2. This is due to one of the following conditions:

- You entered an incorrect Admin Password in Step 3.
- No activity was detected within 10 seconds in the Admin Mode.

Exiting the Admin Mode

To exit the User Mode, press the “**Cancel**” button on the diskAshur DT keypad. If there is no activity for 5 seconds the drive will lock and go into Standby mode.



Alternately, you can turn your diskAshur DT OFF at the power switch on the back of the unit. Once you turn the diskAshur DT ON again, the LOCK indicator light will be RED, indicating that you are in the Standby Mode.

Password Management

This section provides information about managing your password in the Admin Mode and User Mode.

Changing the Admin Password

You can change the Admin Password by doing the following:

1. Enter Admin Mode (refer to page 9 for details).
2. Press and hold  + 9 until the ADMIN (A) indicator light flashes BLUE.
3. Enter the new password and press  (The Password must be a minimum of 6 digits and a maximum of 16 digits). The UNLOCK indicator light flashes GREEN three times. See note below.
4. Re-enter the new Admin Password and press . The UNLOCK indicator light will be solid GREEN for two seconds and then the ADMIN (A) indicator light will become solid BLUE indicating that the Admin Password has been changed successfully.



Note: If the LOCK indicator light flashes RED three times, this indicates that the password is less than 6 digits or more than 16 digits. Enter a password that contains 6 – 16 digits after the ADMIN (A) indicator light flashes BLUE intermittently.

1. If the LOCK indicator light flashes RED intermittently and then the ADMIN (A) BLUE intermittently, go back to step 3. This is due to one of the following conditions:
 - You waited longer than 10 seconds before entering a password.
 - The new password was entered incorrectly.
2. If no activity is detected within two minutes in the Admin Mode, the diskAshur DT will return to the Standby Mode.

Adding a new User Password

You can add a new User Password by doing the following:

1. Enter the Admin Mode (refer to page 9 for details).
2. Press and hold **■** + 1 until the ADMIN (A) indicator light flashes BLUE intermittently.
3. Enter a User Password and press **■** (a minimum of 6 digits and a maximum of 16 digits). The UNLOCK indicator light will flash GREEN three times.
4. Immediately re-enter the new User Password and press **■**. If the UNLOCK indicator light goes GREEN for two seconds and then the ADMIN (A) indicator light goes to solid BLUE, the User Password was added successfully.

Deleting the User Passwords

You can delete all User Passwords by doing the following:

1. Enter the Admin Mode (refer to page 9 for details).
2. Press and hold 7 + 8 + **■** for five seconds until the ADMIN (A) indicator light flashes BLUE intermittently. After the UNLOCK indicator light will flash GREEN three times and then the ADMIN (A) indicator light will flash BLUE intermittently.
3. Press and hold 7 + 8 + **■** a second time for five seconds until the UNLOCK indicator light goes solid GREEN for two seconds. Then the ADMIN (A) indicator light will go back to solid BLUE. This indicates that the User Passwords were deleted successfully.

Changing the User Password

You can change the User Password by doing the following:

1. Enter User Mode (refer to page 8 for details).
2. Press and hold **■** + 1 until the LOCK indicator light flashes RED.
3. Enter your old password and press **■**. The UNLOCK indicator light will turn GREEN, then the ADMIN (A) indicator light will change to flashing BLUE.
4. Enter the new password and press **■** (The Password must be a minimum of 6 digits and a maximum of 16 digits). The UNLOCK indicator light will flash GREEN three times.
5. Immediately re-enter the new User Password and press **■**. The UNLOCK indicator light will stay solid GREEN indicating that the User Password has been changed successfully.



Setting the Unattended Auto Lock Feature

To protect against unauthorized access if the drive is unlocked and unattended, the diskAshur DT can be set to automatically lock after a pre-set amount of time.

In its default state, the diskAshur Unattended Auto Lock feature is turned off.

The Unattended Auto Lock can be set to activate after 5, 10 or 20 minutes.

To set the Unattended Auto Lock please use the following steps:

1. Enter the Admin mode by pressing and holding  + 0 for five seconds until the LOCK indicator light flashes RED. This indicates that you can enter the Admin Password.
2. Enter the Admin Password and press . The drive is in Admin Mode when the ADMIN (A) indicator light has changed to BLUE.
3. Once in Admin mode, press  + 6. The LOCK and ADMIN (A) indicator lights should start flashing RED and BLUE intermittently.
4. Press one of the numbers below that corresponds to amount of time you would like the drive to lock after no activity:

Auto Lock Timeout Table:

1 = 5 min
2 = 10 min
3 = 20 min
0 = OFF

The default is 0 (OFF)

5. After you have input the number, the UNLOCK indicator light should flash GREEN 3 times to indicate that you have successfully set the Unattended Auto Lock feature.

diskAshur DT Brute Force Protection

What is Brute Force Attack?

A brute force attack is a method of defeating a cryptographic scheme by systematically trying a large number of possibilities; for example, a large number of the possible keys in a key space in order to decrypt a message. In most schemes, the theoretical possibility of a brute force attack is recognized, but it is set up in such a way that it would be computationally infeasible to carry out. Accordingly, one definition of “breaking” a cryptographic scheme is to find a method faster than a brute force attack.

How does the diskAshur DT protect against brute force attack?

1. With the drive locked and in the standby state the LOCK indicator light will be solid RED.
2. After six tries to enter the correct user or admin password the keypad will not respond and LOCK indicator light will turn off. The drive will need to be unplugged from the USB port and replugged. This will be repeated for each six unsuccessful attempts.
3. If the user unsuccessfully tries to unlock the drive on his 10th try the keypad will lock and the LOCK indicator light will begin blinking quickly. Even after unplugging and replugging in the unit, the drive will remain locked and the indicator light will continue to blink rapidly.
4. Here are the steps to allow the user to unlock the keypad for 10 more attempts to unlock his drive.
 - a. Unplug the device from the computer
 - b. Push and hold the number five key and plug-in the drive
 - c. The LOCK and UNLOCK indicator lights will flash rapidly between RED and GREEN.
 - d. Enter the code **5278879**
 - e. The keypad will unlock. The LOCK indicator light will be solid RED indicating that the drive is in the standby state. This will allow only 10 more attempts
 - g. After a total of 30 attempts the drive will lock. The LOCK indicator light will flash RED quickly. You must now go through the reset process and reformat the drive to be able to use the drive again. (see page 15)





Setting a Self Destruct Password

The diskAshur DT has the ability to set a password that will reset the encryption key if needed. By resetting the encryption key all data on the drive will be lost and cannot be recovered.



After initiating the Self Destruct sequence, the PIN used to initiate the self destruct sequence will become the default Admin password. The drive will need to be initialized and reformatted. For directions see page 15.

To set a Self Destruct password please use the following steps:

1. Enter the Admin mode by pressing and holding  + 0 for five seconds until the LOCK indicator light flashes RED. This indicates that you can enter the Admin Password.
2. Enter the Admin Password and press . The drive is in Admin Mode when the ADMIN (A) indicator light has changed to BLUE.
3. Once in Admin mode, press  + 3. The LOCK and ADMIN (A) indicator lights should start flashing RED and BLUE intermittently.
4. Input in the PIN that you would like to use as the Self Destruct password and press .



Note: The PIN must be a minimum of 6 digits in the length (16 max) and cannot match any Admin or User codes already used by the drive.

In the future, a User or Admin code can not be set to the same number as used by the Self Destruct password.

5. The diskAshur DT will then check against known PINs to make sure that it is not already in use. If in use the LOCK indicator light will flash RED 3 times and the drive will go into Standby mode. If this happens please re-enter the Admin mode (step 1) and repeat the process with a new code.
6. If the Self Destruct password is accepted the UNLOCK indicator light flashes GREEN three times.
7. Immediately re-enter the new PIN and press . If the UNLOCK indicator light stays solid GREEN for two seconds and then the ADMIN (A) indicator light goes to solid BLUE, the Self Destruct PIN was added successfully.
8. To delete the Self Destruct password, you will need to delete all of the User Passwords. Please refer to the instructions on page 11 - Deleting User Passwords.

Completely resetting the diskAshur DT

If you forget all the User Passwords or Admin Passwords, you can perform a complete reset to remove all the User Passwords, and restore the Admin Password to the default **123456**.



Attention: Completely resetting the diskAshur DT will reset the encryption key, in effect making all the data on the drive unrecoverable. You will need to partition and format the diskAshur DT with disk management applications.

To perform a complete reset of the drive, do the following:

1. Press and hold the “**Cancel**” button while you attach the diskAshur DT to an available USB port on your computer. The ADMIN (A) and LOCK indicator lights will flash BLUE and RED alternately.

Note: If no activity is detected for 30 seconds in this step, the diskAshur DT will go into the Standby Mode.

2. Press and hold “**Cancel**” +  + 2 for 10 seconds until the LOCK and ADMIN (A) indicator lights flash RED and BLUE intermittently, and then stop on a solid color. The indicator light will then turn solid GREEN for two seconds, followed by the LOCK indicator light turning solid RED. You have successfully reset the diskAshur DT.

Initializing and formatting the diskAshur DT after a complete reset

A complete reset of the diskAshur DT will erase all information and partition settings. You will need to initialize and format the diskAshur DT.

To initialize your diskAshur DT, do the following:

1. After a complete reset, attach the diskAshur DT to the computer.
2. Wait 5 seconds for the computer to recognize the device.
3. Enter the default User Password **123456** and press  to enter the User Mode.
4. Right-click **My Computer**, and then click **Manage** from the Windows desktop.

5. In the Computer Manage window, click **Disk Management**. In the Disk Management window, the diskAshur DT is recognized as an unknown device that is uninitialized and unallocated.
6. Do the following to make the drive recognized as a basic drive.
 - If the Initialize and Convert Disk Wizard window opens, click **Cancel**, then initialize the disk manually using the following steps.
 - a. Right-click Unknown Disk, and then select Initialize Disk.
 - b. In the Initialize Disk window, click **OK**.
7. Right-click in the blank area under the Unallocated section, and then select New Partition. The Welcome to the New Partition Wizard window opens.
8. Click **Next**.
9. Select Primary partition and click **Next**.
10. If you need only one partition, accept the default partition size and click **Next**.
11. Click **Next**.
12. Create a volume label, select Perform a quick format, and then click **Next**.
13. Click **Finish**.
14. Wait until the format process is complete. The diskAshur DT will be recognized and it is available for use.

Hibernating, Suspending, or Logging off from the Operating System

Be sure to save and close all the files on your diskAshur DT before hibernating, suspending, or logging off from the Windows operating system.

It is recommended that you log off the diskAshur DT manually before hibernating, suspending, or logging off from your system.

To log off the diskAshur DT, double-click Safely Remove Hardware on the Windows desktop and remove the diskAshur DT from your computer.



Attention: To ensure the data integrity of your diskAshur DT, be sure to lock or log off your diskAshur DT if you are:

- away from your computer
- using the switching user function by sharing a computer with others

Troubleshooting

This section contains troubleshooting information for the diskAshur DT. If you encounter any of the following problems when using the diskAshur DT, refer to the corresponding answers.

Q: How do I use the diskAshur DT the first time?

A: You can use it in one of the following ways:

- Enter the Admin Mode with **123456** (default administrator password), and then you are able to change the Admin Password or create a User Password
- Directly enter the Secure User Mode with **123456** (default Admin Password) to use the diskAshur DT

Q: I enter the drive with the default password but am not able to change the code. Why?

A: You are entering the drive using the Admin password. This code can only be changed from the Admin mode.

Q: What can I do if I forget the User Password?

A: Use your Admin Password to enter Admin Mode, and then create another User Password in Admin Mode.

Q: What can I do if I forget the Admin Password?

A: There is no other way to retrieve the Admin Password except a complete reset of the diskAshur DT. After a complete reset, all data will be lost and you will need to initialize, allocate and format the diskAshur DT manually. Then you will be able to use the default Admin Password **123456**.

Q: Why did the operating system not recognize the diskAshur DT after I enter the User Mode and completely reset the computer?

A: You need to initialize, allocate and format the diskAshur DT manually. For more information, refer to **Initializing and formatting the Hard Drive after a complete reset** in this manual.

Q: How do I use the diskAshur DT without a password?

A: As a full disk encryption product, the diskAshur DT can never be used without a password.

Q: What encryption algorithm is used in this product?

A: Depending on your model the diskAshur DT uses either AES 128-bit or 256-bit algorithm.

Q: Why could I not initialize, partition or format the diskAshur DT?

A: Ensure that your user account has administrator privileges. Only accounts with Administrator privileges have access to Disk Management and the permissions to format and partition drives.

Technical Support

iStorage provides the following helpful resources for you:

1. iStorage's Website (<http://www.istorage-uk.com>)

This gives you the ability to check for up-to-date information.

2. E-mail us at support@istorage-uk.com

3. Or call the Technical Support Department at **+44 (0) 20 8537-3435**.

iStorage's Technical Support Specialists are available from 8:00 a.m. to 5:00 p.m., GMT, Monday through Friday.

Warranty and RMA information

Three Year Limited Warranty:

iStorage offers a 3-year limited warranty on the diskAshur DT against defects in materials and workmanship under normal use. The warranty period is effective from the date of purchase either directly from iStorage or an authorized reseller.

Disclaimer and terms of the warranties:

THE WARRANTY BECOMES EFFECTIVE ON THE DATE OF PURCHASE AND MUST BE VERIFIED WITH YOUR SALES RECEIPT OR INVOICE DISPLAYING THE DATE OF PRODUCT PURCHASE.

ISTORAGE WILL, AT NO ADDITIONAL CHARGE, REPAIR OR REPLACE DEFECTIVE PARTS WITH NEW PARTS OR SERVICEABLE USED PARTS THAT ARE EQUIVALENT TO NEW IN PERFORMANCE. ALL EXCHANGED PARTS AND PRODUCTS REPLACED UNDER THIS WARRANTY WILL BECOME THE PROPERTY OF ISTORAGE.

THIS WARRANTY DOES NOT EXTEND TO ANY PRODUCT NOT PURCHASED DIRECTLY FROM ISTORAGE OR AN AUTHORIZED RESELLER OR TO ANY PRODUCT THAT HAS BEEN DAMAGED OR RENDERED DEFECTIVE: 1. AS A RESULT OF ACCIDENT, MISUSE, NEGLIGENCE, ABUSE OR FAILURE AND/OR INABILITY TO FOLLOW THE WRITTEN INSTRUCTIONS PROVIDED IN THIS INSTRUCTION GUIDE; 2. BY THE USE OF PARTS NOT MANUFACTURED OR SOLD BY ISTORAGE; 3. BY MODIFICATION OF THE PRODUCT; OR 4. AS A RESULT OF SERVICE, ALTERNATION OR REPAIR BY ANYONE OTHER THAN ISTORAGE AND SHALL BE VOID. THIS WARRANTY DOES NOT COVER NORMAL WEAR AND TEAR.

NO OTHER WARRANTY, EITHER EXPRESS OR IMPLIED, INCLUDING ANY WARRANTY OR MERCHANTABILITY AND FITNESS FOR A PARTICULAR PURPOSE, HAS BEEN OR WILL BE MADE BY OR ON BEHALF OF ISTORAGE OR BY OPERATION OF LAW WITH RESPECT TO THE PRODUCT OR ITS INSTALLATION, USE, OPERATION, REPLACEMENT OR REPAIR.

ISTORAGE SHALL NOT BE LIABLE BY VIRTUE OF THIS WARRANTY, OR OTHERWISE, FOR ANY INCIDENTAL, SPECIAL OR CONSEQUENTIAL DAMAGE INCLUDING ANY LOSS OF DATA RESULTING FROM THE USE OR OPERATION OF THE PRODUCT, WHETHER OR NOT ISTORAGE WAS APPRISED OF THE POSSIBILITY OF SUCH DAMAGES.



© iStorage, 2011. All rights reserved.
iStorage Limited, Research House, Fraser Road
Greenford, Middx. UB6 7AQ
England

www.istorage-uk.com